

PICOQUANT

# Photon Counting and Timing

Reliable and easy-to-use modules with high-end performance

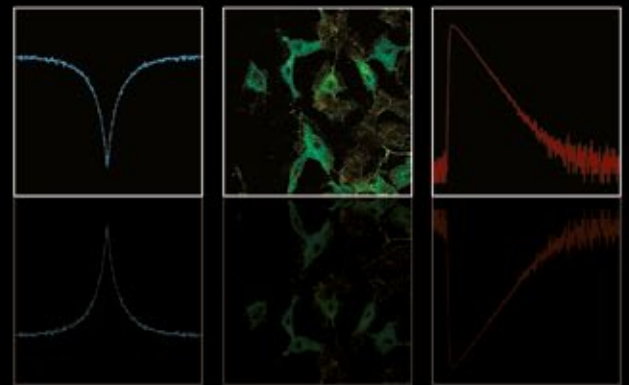

# Photon Counting and Timing

Reliable and easy-to-use modules with high-end performance

PicoQuant's wide range of products for photon counting and timing include several high-end modules for time-correlated single photon counting (TCSPC) and event timing, single photon sensitive detectors, and specialized analysis software for the evaluation of (time-resolved) fluorescence measurements.

Time-resolved photon detection is a standard measurement method in today's research. It is an extraordinarily capable and versatile optical measurement technique, which by design and definition uses only single quanta of light and therefore matches the requirements of applications where the light emission to be observed is very weak. PicoQuant has paved the way to employ the time-resolved photon detection method in a constantly increasing number of applications by designing reliable and easy-to-use timing and detection modules. Our confidence in the quality of our products is especially emphasized by a 5-year warranty on all TCSPC and time tagging modules.

Don't hesitate to contact us for more information about the technology. We are always happy to discuss your individual requirements in detail. Your needs drive our development.

## PMA Hybrid Series Hybrid Photomultiplier

- Timing resolution down to  $< 50$  ps
- Detection efficiency up to 45 %



## PMA Series Photomultiplier

- Timing resolution  $< 180$  ps
- Quantum efficiency up to 40 %



## SymPhoTime 64

Fluorescence lifetime imaging and correlation software

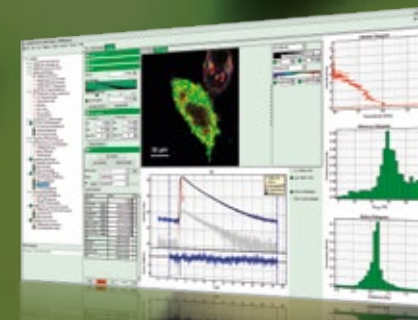

## FluoFit

Fluorescence decay and anisotropy analysis software

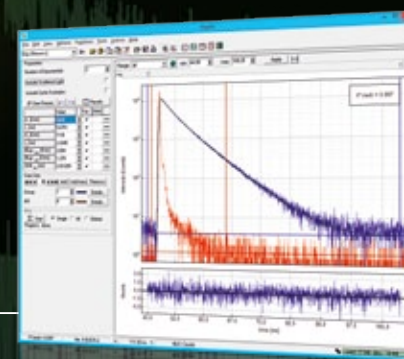

## HydraHarp 400

Multichannel TCSPC module

- Up to nine input channels
- Minimum time bin width 1 ps



## PicoHarp 300

TCSPC module

- Two input channels
- Minimum time bin width 4 ps



## TimeHarp 260

TCSPC and MCS board

- Two or three input channels
- Minimum time bin width 25 ps or 250 ps



# Time-Correlated Single Photon Counting

## Accurate measurement of photon arrival times

Time-Correlated Single Photon Counting (TCSPC) is the most powerful and sensitive method to measure the temporal structure of weak optical signals. Technically it is based on the generic measurement of photon arrival times and time differences on time scales down to picoseconds. The method can therefore be used in a great range of applications, from the measurement of fluorescence lifetimes to time-of-flight applications like LIDAR, and fundamental correlation studies in quantum optics.

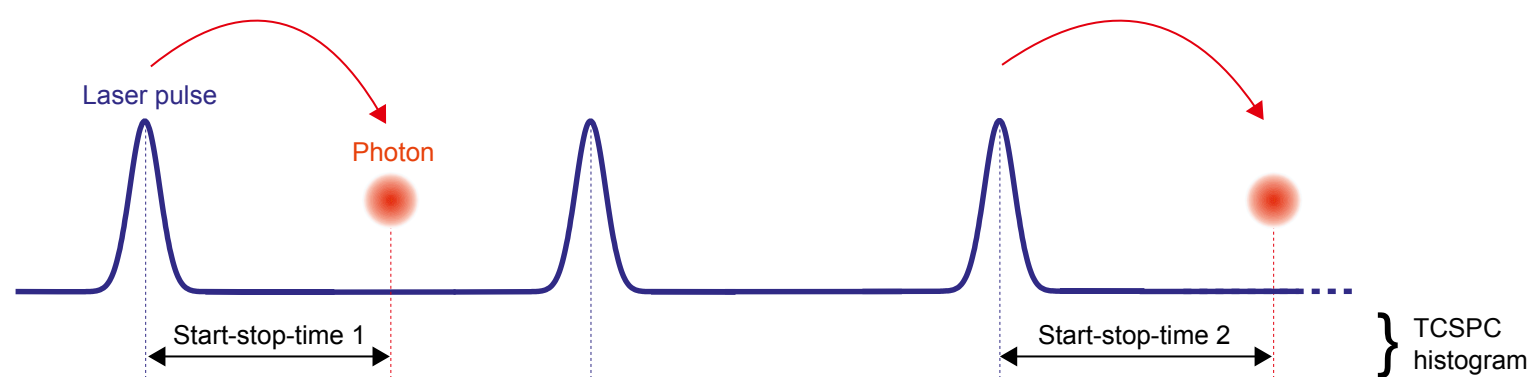

Classical Time-Correlated Single Photon Counting (TCSPC) measures the time difference between two signals, usually from a single photon sensitive detector and a reference signal from a pulsed laser.

Time-Correlated Single Photon Counting (TCSPC) is a technique to record low level light signals with a temporal resolution down to picoseconds. It is one of the basic supported measurement methods of all PicoQuant modules. The method is based on the repeated measurement of time differences between two signals, which are typically

the output of a single photon sensitive detector and a corresponding reference signal from, e.g., an excitation source. The method is essentially similar to applying a stop watch. Provided that the probability of registering more than one photon per cycle is low, the histogram of photon arrivals per time bin represents the signal one would have obtained from a single shot time-resolved analog recording.

### Modern Time-to-Digital converter design

Traditional TCSPC electronics were based on a Time-to-Amplitude Converter (TAC), which is essentially a highly linear ramp generator that is started by one signal and stopped by the other. The result is a voltage proportional to the time difference between the two signals, which is then digitized. This design has, however, limitations in, e.g., the time range it can cover and the maximum data rate it can handle. All PicoQuant TCSPC modules are therefore not based on a TAC design, but use a fully digital circuit to measure the time differences, a so-called Time-to-Digital

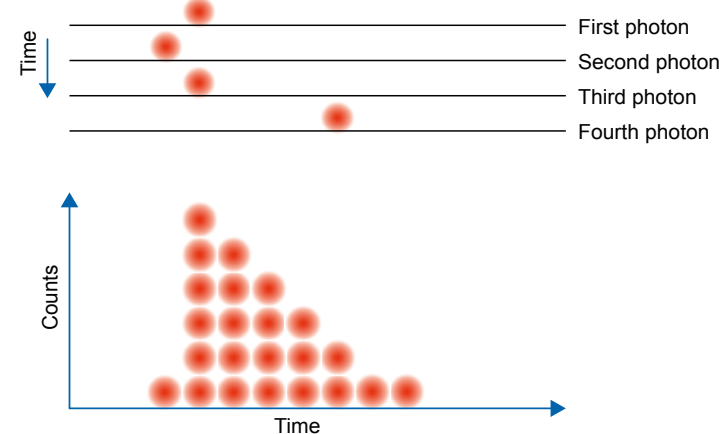

All measured time differences are sorted into a histogram that represents the signal one would have obtained from a single shot time-resolved analog recording.

Converter (TDC). TDC based systems also offer other advanced capabilities such as integrated programmable delays, forward start-stop operation and independent channels, which have led to the development of various new applications not possible with classical TCSPC modules. Even ultrashort dead times and thus high data throughput has become possible using a custom TDC in a specific integrated circuit (ASIC) design by PicoQuant.

### Multi-stop capability for higher throughput

Another feature of advanced TDC based TCSPC systems is their multi-stop capability. While TAC based systems can process only one photon per excitation cycle, modern systems with TDCs and independent channels can record multiple photons per cycle, provided the cycle is longer than the dead time of the detector and the TDC. This is commonly the case in luminescence and phosphorescence measurements where lifetimes are in the range of micro- to milliseconds. In those cases, TDC based system lead to a much higher data throughput than TAC based systems.

### Temporal resolution down to picoseconds

The characteristic value of a complete TCSPC set-up that summarizes its overall timing precision is its Instrument Response Function (IRF), which depends on the temporal uncertainties of all components involved. These are typically the laser pulse width, the detector jitter, and timing uncertainty of the TCSPC system itself. Strictly speaking, the total IRF is the convolution of all component IRFs, but an estimate of the total IRF can be obtained from the geometric sum of the individual components, e.g., in the form of r.m.s. or FWHM values according to statistical error propagation laws. The achievable temporal resolution of a TCSPC set-up is therefore dominated by the slowest component, which is usually the detector. The shortest IRF using PicoQuant TCSPC modules can be achieved in combination with fs laser sources and an ultrafast detector such as a MCP-PMT.

*“The different measurement modes of PicoQuant TCSPC modules allow us to perform a wide range of applications with just a single device.”*

*W.E. Moerner, Stanford University, USA,  
Nobel Prize Laureate*

This combination results in an IRF of around 30 ps (FWHM). Along with a numerical deconvolution analysis, this will allow to resolve dynamics down to a few picoseconds.

### Photon counting rates in the MHz range

Although TCSPC works on the single photon level, it can still give quick and reliable results. Photon counting rates up to tens of MHz and synchronization signal rates of more than 80 MHz can easily be handled by all PicoQuant modules. Reliable results can therefore easily be obtained in one second or less.

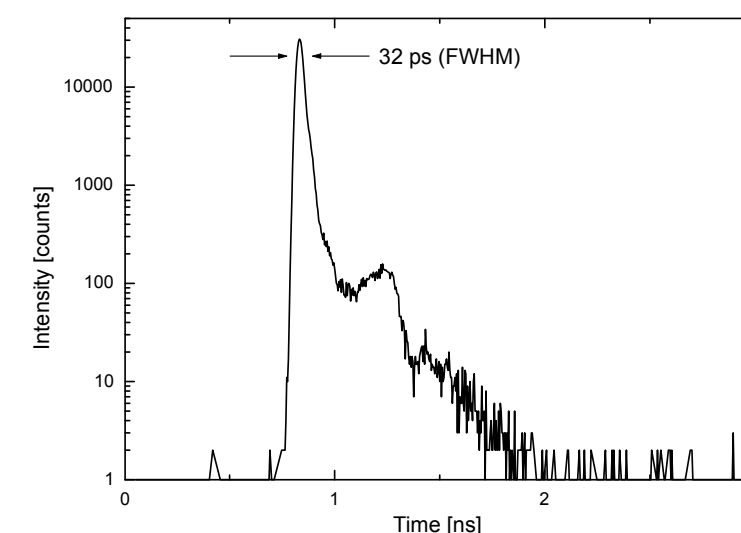

Example of an IRF of 32 ps (FWHM), obtained with TCSPC in combination with a MCP-PMT detector and a fs laser. This combination allows to study dynamics down to a few picoseconds. The shoulder around 1.2 ns is a typical feature of MCP-PMT detectors.

# Time-Tagged Time-Resolved Mode

## Timing of individual photons or other events

Time-Tagged Time-Resolved (TTTR) data acquisition allows the recording of individual events. The timing of each signal is captured as an event record without any early data reduction (such as hardware based formation of histograms). This mode is particularly interesting where dynamic processes or correlations are to be investigated in detail.

Classical TCSPC in histogramming mode is an early form of data reduction. It is, for example, not possible to access individual signal arrival times, which is necessary for advanced correlation measurements. Synchronizing the data acquisition with a scanning system is also only possible with limited functionality. To overcome this limitation, all PicoQuant TCSPC units include two fundamentally different Time-Tagged Time-Resolved measurement (TTTR) modes. The core idea of these T2 and T3 modes is to introduce an additional timing information that represents the time difference since the start of the measurement on an absolute scale. Along with the possibility to measure on several channels simultaneously and to include external synchronization signals ("markers") into the data stream, TTTR mode data files include the complete photon dynamics without any loss of information and also permit to recover a theoretically infinite time span.

### T3 mode for periodic sync signals

The T3 mode is similar to classic TCSPC in histogramming mode. It is specifically designed to use periodic pulsed synchronization signals with repetition rates of up to 150 MHz. In addition to measuring the start-stop timing on the picoseconds time scale, the channel number is recorded and each event is time-tagged with respect to the beginning of the experiment. The time tag is obtained by simply counting the synchronization pulses. From the event recorded in T3 mode it is therefore possible to precisely determine which synchronization period a photon event belongs to. Since the synchronization period is also known precisely, this allows to reconstruct the arrival time of the photon with respect to the overall experiment time.

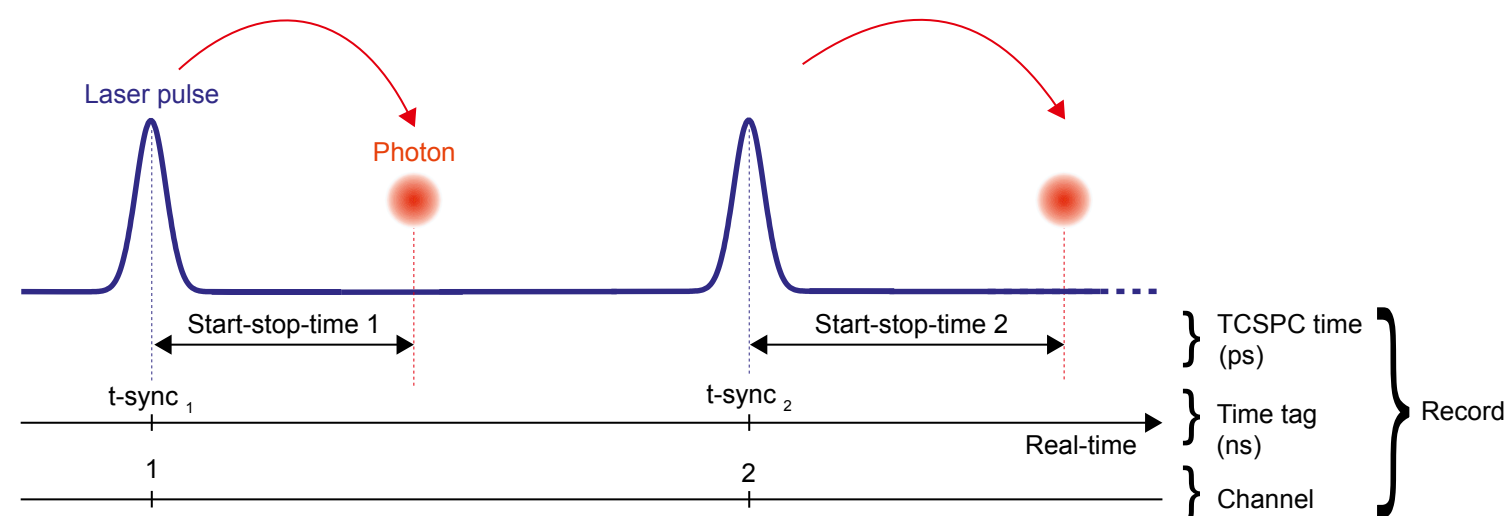

In T3 mode, the time difference between photon and synchronization signal is measured and stored along with the detection channel number and the corresponding number of the synchronization signal. The latter info can be used to reconstruct the arrival time of a photon on an absolute scale.

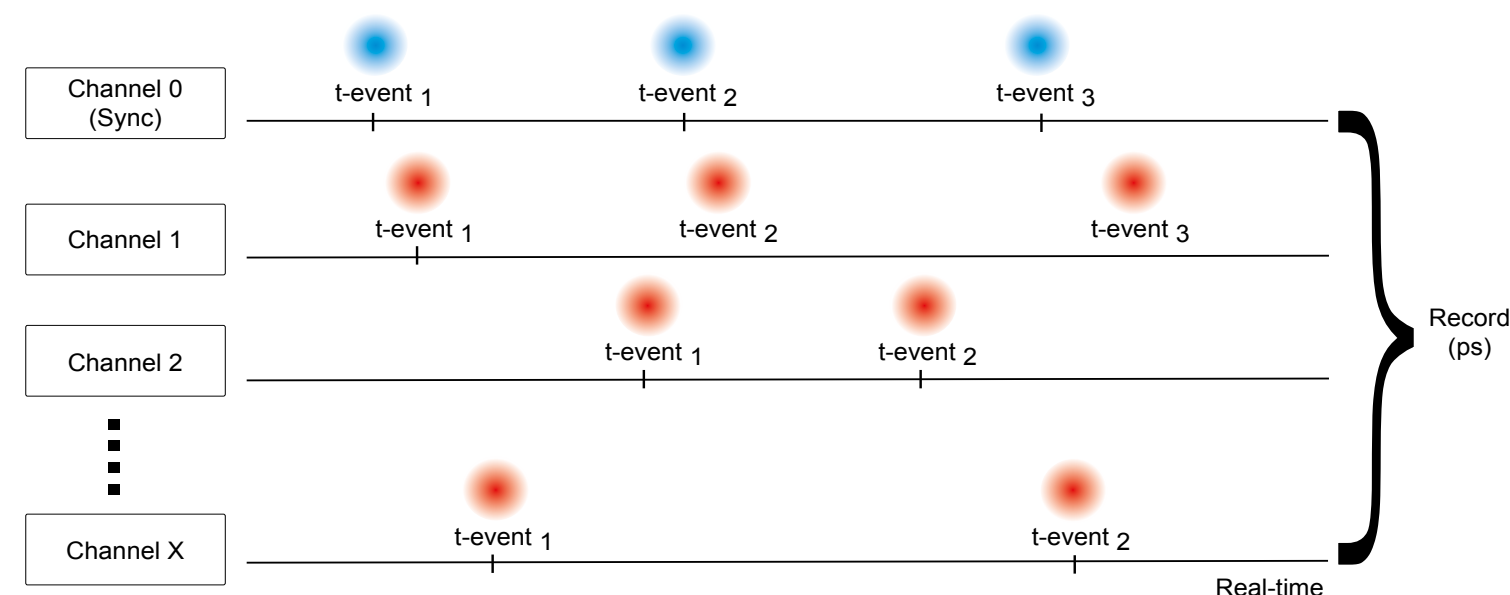

In T2 mode, all signal inputs are functionally identical and measure the arrival time of signals on an absolute time scale.

### T2 mode for absolute arrival times

In T2 mode, all signal inputs are functionally identical. There is no channel dedicated to a synchronization signal and all inputs can be used to connect photon detectors. The events from all channels are recorded independently and treated equally. In each case, an event record is generated that contains information about the channel it came from and the arrival time with respect to the overall measurement start. Dead times exist only within each channel but not across the channels, which permits, e.g., the calculation of cross-correlations down to zero lag time or the implementation of dedicated coincidence detection schemes.

### External event markers

Both TTTR modes support capturing up to four external marker events that can be fed to the instrument as TTL signals. These events are recorded as part of the TTTR data stream with their arrival time since the start of the

measurement. This allows to precisely synchronize the TTTR measurement with almost any experiment, such as, e.g., scanners for time-resolved imaging applications.

*“The PicoHarp 300 provides us with flexibility and high reliability and we get data at a good level of throughput and in the right format for subsequent data processing.”*

*Gerald S. Buller, Heriot-Watt University, Edinburgh, UK*

# Methods and Applications

## From fundamental research to practical applications

High resolution time measurement on electrical pulse trains is a generic task in many areas of metrology and engineering. While modern oscilloscopes can be used for some of these tasks, they often deal poorly with recording long sequences at high resolution. PicoQuant's event timers and TCSPC units overcome these problems since they allow recording continuous streams of events at high input rates.

### Fluorescence Lifetime Measurements

The fluorescence (or in general photoluminescence) lifetime is characteristic for each fluorescent or phosphorescent molecule, and can thus be used to characterize a sample. It is defined as the average time that a molecule remains in an excited state prior to returning to the ground state by emitting a photon. Processes like Förster Resonance Energy Transfer (FRET), quenching, charge transfer, solvation dynamics, molecular rotation as well as the chemical composition of the environment have an additional effect on the decay kinetics. Lifetime changes can therefore be used to gain information about the local chemical environment or to follow reaction mechanisms. The fluorescence lifetime can be measured in various environments and sample types such as liquids, solids, wafers, or powders.

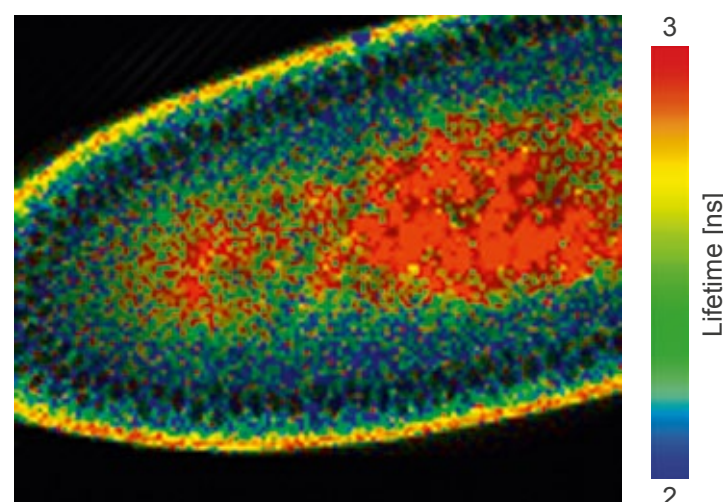

Fluorescence Lifetime Image (FLIM) based on the auto-fluorescence of an embryo of the fruit fly *Drosophila*. The image clearly shows that the fluorescence originates mainly from yolk granules and the vitelline membrane. Image size approx. 200  $\mu\text{m}$  x 180  $\mu\text{m}$ . Sample courtesy of S. Weidtkamp-Peters, R. Kühnemuth, C. A. M. Seidel, University of Düsseldorf, Germany

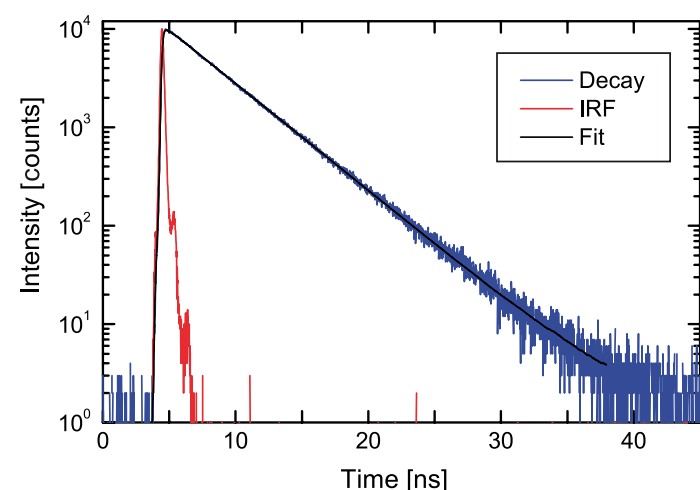

Fluorescence lifetime analysis of a 1  $\mu\text{M}$  Fluorescein solution in pH 10 phosphate buffer. The picture shows the measured fluorescence decay (blue), the Instrument Response Function (red) and the fitted single exponential curve (black). The recovered lifetime is 3.99 ns.

Fluorescence lifetime measurements can even be used to generate two-dimensional images. Such Fluorescence Lifetime Imaging (FLIM) measurements are performed by raster scanning the sample with a beam or sample scanner. At each pixel, the fluorescence lifetime is measured and displayed in a false-color code. In that way, an additional dimension is created compared to conventional fluorescence intensity imaging. Since FLIM is not affected by fluctuations in the fluorescence intensity, it permits to discriminate between fluorophores with similar emission spectra (like Atto655 and Cy5) and from auto-fluorescence. It can be used to probe local environmental conditions (e.g., pH value), to determine ion concentrations, to study intracellular signal transduction or, to distinguish between different tissue components.

### Coincidence correlation/ Antibunching

Coincidence correlation with picosecond timing has a wide range of applications from life sciences to quantum optics. In quantum optics, coincidence correlations between several detector signals are used to study phenomena such as quantum entanglement or for dedicated quantum cryptography schemes. The technique can also be used to determine if one is actually observing a single quantum system in the form of a single photon emitter. Since a molecule in an excited state requires a finite amount of time before it relaxes back to the ground state by emitting a photon, two detectors observing the same source simultaneously cannot detect a photon at the same time. The temporal separation between adjacent photons is determined mostly by the excited-state lifetime. This effect is known as

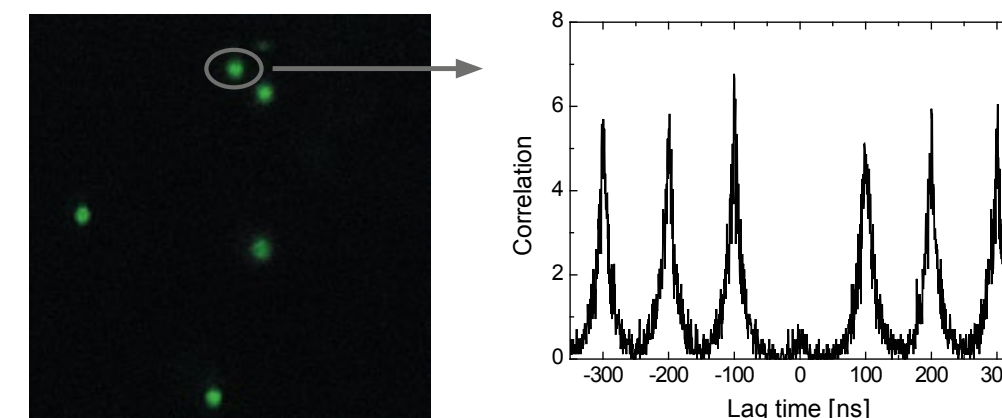

Antibunching measurement of Nitrogen Vacancy (NV) centers in diamond. The FLIM image was first used to locate the NV centers. The missing peak at lag time zero in the antibunching trace then proves that there is indeed only a single fluorescent emitter in the nanocrystal under investigation. Image size approx. 13  $\mu\text{m}$  x 13  $\mu\text{m}$ . Sample courtesy of J. Wrachtrup, University of Stuttgart, Germany

antibunching and manifests the sub-Poissonian nature of the emitted light. The technique is very often employed in the characterization of single quantum systems such as single molecules, quantum dots, carbon nanotubes, defect centers in diamond nanocrystals, or in applications based on single photons sources.

### Time-of-Flight/Ranging/LIDAR/Metrology

Time-of-Flight (ToF) refers to a variety of methods that measure the time it takes for an object (photon, electron, ion, etc.) to travel a distance through a medium. It is a fundamental measurement method that is used for many different applications such as mass spectrometry, bunch purity measurements in synchrotron rings, ranging, or LIDAR. LIDAR, which is an acronym for Light Detection And Ranging, is a remote sensing method that uses light in the form of a pulsed laser to measure variable distances, in order to, e.g., determine the concentration of aerosols in the atmosphere. In combination with appropriate scanning systems, ToF measurements can even be used to build three-dimensional depth images of remote targets or for emerging applications such as transient imaging.



Depth imaging using the single-photon time-of-flight approach with picosecond resolution. The figure illustrates a close-up photograph of a mannequin and a representation of the corresponding cm-resolution depth image when measured at a distance of 325 m under daylight conditions. Data courtesy of G. Buller, Heriot-Watt University, Edinburgh, UK (Opt.Exp. 21, 8907 (2013))

# PicoHarp 300

## Stand-alone TCSPC module with USB interface

The PicoHarp 300 is a high-end, easy-to-use Time-Correlated Single Photon Counting and time tagging system, which is connected to the host computer through a USB 2.0 interface. The PicoHarp 300 features two independent input channels with a temporal resolution of 4 ps. Up to 4 detectors can be connected to the PicoHarp 300 via an optional multiplexer unit (PHR 800).



### KEY FEATURES

- two identical, synchronized but independent input channels
- 65536 histogram time bins, minimum width 4 ps
- time tagging with sustained count rates up to 5 Mcps
- histogrammer measurement range up to 33  $\mu$ s



### Application example

#### Fluorescence lifetime measurements

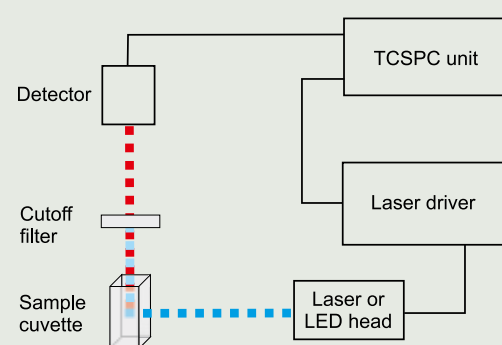

Sketch of a basic set-up for fluorescence lifetime measurements. The fluorescence lifetime is ideally measured using Time-Correlated Single Photon Counting (TCSPC) along with a pulsed excitation source with short pulses and variable repetition rate (such as pulsed diode lasers or LEDs).

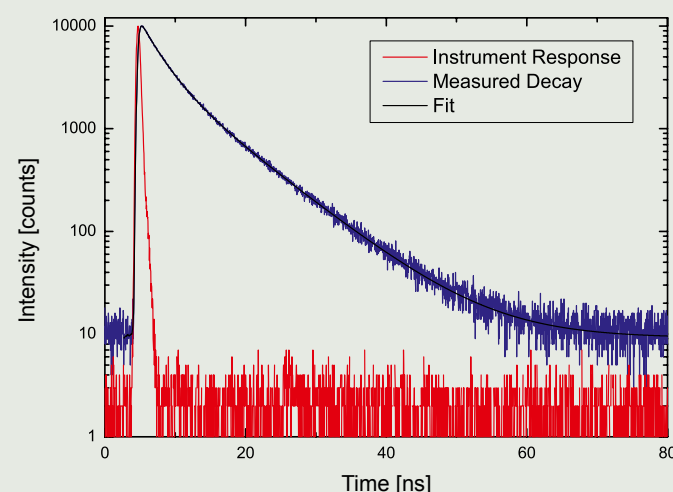

This example shows the fluorescence lifetime measurement of L-Tryptophane in water, excited with a pulsed LED and recorded with the PicoHarp 300 using TCSPC. As can be expected for L-Tryptophane, the decay is best described by a triple exponential decay function. The recovered lifetimes are 0.35 ns, 2.65 ns, and 7.93 ns.

### Two independent channels, 4 ps resolution

The PicoHarp 300 is designed to provide two identical and synchronized but independent input channels. They can be used as detector inputs for coincidence correlation experiments or as a pair of start and stop inputs for TCSPC. It allows a forward start-stop operation even at full repetition rate of excitation lasers with a stable repetition rate of up to 84 MHz.

The input channels feature a dead time of < 95 ns, which allows high measurement rates of up to 10 million counts/sec at a highly stable, crystal calibrated time resolution of 4 ps. Along with the extremely low differential non-linearity of the instrument, data with excellent quality can be obtained. The instrument's timing resolution is well matched even to the fastest detectors currently available on the market. Both input channels are equipped with Constant Fraction Discriminators (CFD) triggering on the falling edge.

### Adjustable delay in the sync channel

An internal adjustable delay in the sync channel of the PicoHarp 300 with a  $\pm 100$  ns range permits to adjust the relative timing between input signals with 4 ps resolution. This unique feature of PicoQuant timing electronics eliminates the need for specially adapted cable lengths or cable delays for different experimental set-ups.

### Histogramming range up to 33 $\mu$ s

The PicoHarp 300 offers 65536 histogram bins and allows to collect up to 65535 counts (32 bits) per bin. Histograms can cover a large time span between 260 ns and 33  $\mu$ s, depending on the chosen resolution per time bin, which can be varied between 4 ps and 512 ps.

### Time tagging at 5 million events/sec

The PicoHarp 300 permits capturing time-tagged data in T2 and T3 mode with a sustained throughput of typically 5 million events/sec. External signals can be used to synchronize the device with other hardware such as scanners for, e.g., Fluorescence Lifetime Imaging (FLIM).

### Up to 4 detectors via routing

An external multiplexer or "router" can be added to the PicoHarp 300, permitting to attach up to four detectors to the device. Each router channel includes an internal adjustable delay with a  $\pm 8$  ns range at 4 ps resolution to fine-tune the relative delay between the four detectors. The router supports all typical single photon sensitive detectors such as Single Photon Avalanche Diodes (SPADs), Photomultiplier Tubes (PMTs), Hybrid Photomultiplier Tubes (Hybrid-PMTs) or Microchannel-Plate Photomultiplier Tubes (MCP-PMTs.)

### Easy-to-use software and custom programming

The PicoHarp 300 software for Windows provides all functions necessary to acquire data in histogramming as well as time tagging mode. An integrated online correlator for TTR data permits to monitor Fluorescence Correlation Spectroscopy (FCS) experiments at count rates of up to one million counts/sec. A programming library allows building custom applications using, e.g., LabView, Matlab, C++, or Delphi.

### Application example

#### Fill pattern diagnostics in synchrotron rings

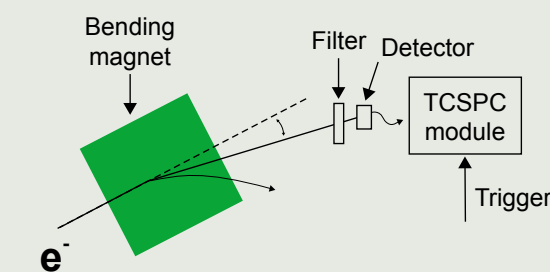

TCSPC is one of the most commonly used methods to measure the bunch purity in a synchrotron ring. The time difference of the single photon signal with respect to the clock pulse synchronized to the rf signal of the storage ring is processed by the TCSPC unit.

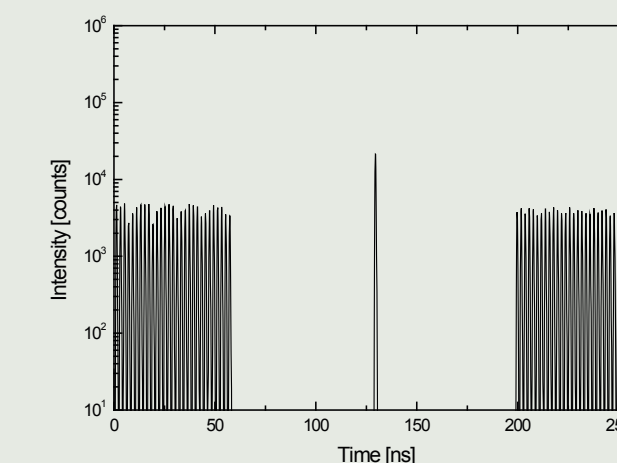

Section of the regular BESSY II hybrid fill pattern recorded with the PicoHarp 300 using a time bin width of 128 ps. Data collection courtesy of Karsten Holldack, Bessy II, Berlin, Germany

# HydraHarp 400



## Multichannel picosecond event timer & TCSPC module

The HydraHarp 400 is a modular, high-end, easy-to-use multichannel event timer and Time-Correlated Single Photon Counting (TCSPC) unit. It is world wide the only instrument of this kind providing a USB 3.0 high speed interface. The HydraHarp 400 features up to 8 independent detection channels with a temporal resolution of 1 ps.

### KEY FEATURES

- up to 8 independent detection channels and common sync channel
- 65536 histogram bins per channel, minimum width 1 ps
- time tagging with sustained count rates of up to 40 Mcps
- histogrammer measurement ranges of up to 2.19 s



### Application example

#### Förster Resonance Energy Transfer (FRET)

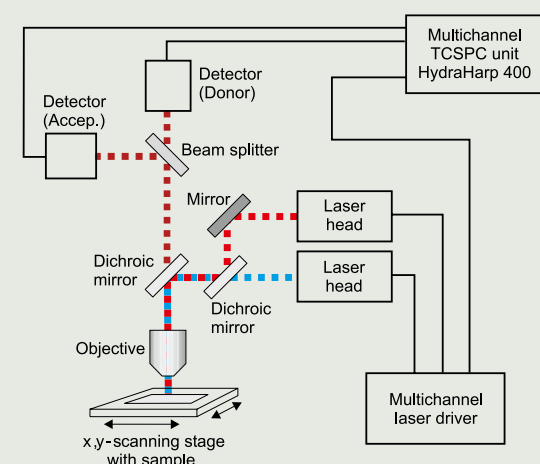

Sketch of a basic set-up for Förster Resonance Energy Transfer (FRET). FRET is a nonradiative process in which energy from a donor molecule is transferred to an acceptor molecule. The rate of energy transfer can be used to measure intermolecular distances.

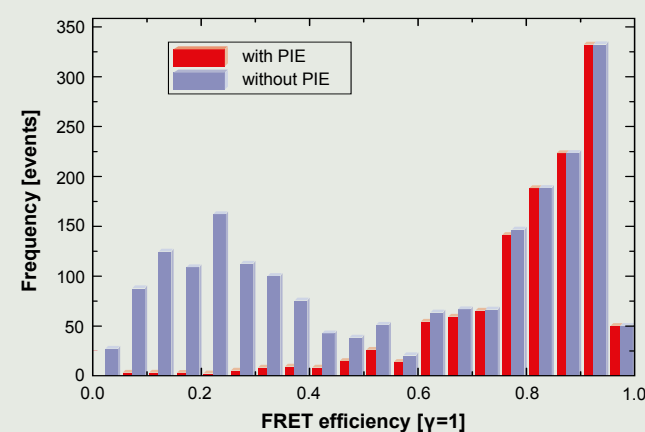

In Pulsed Interleaved Excitation (PIE) two laser pulses are used sequentially to excite the donor and the acceptor molecule independently. The resulting fluorescence emission patterns can be used to discriminate between molecules showing FRET, molecules that do not show FRET, and molecules without acceptor molecule. Data courtesy of Rainer Macdonald, PTB, Berlin, Germany

### Multiple input channels for highly flexible use

The HydraHarp 400 is a unique modular unit that can be equipped with 2, 4, 6, or 8 identical synchronized but independent detection channels. They can be used as detector inputs for coincidence correlation experiments or as independent stop inputs for TCSPC. A dedicated common sync input is provided for TCSPC with fast excitation sources. This allows forward start-stop operation at the full repetition rate of excitation lasers with stable repetition rates of up to 150 MHz. In T2 time tagging operation, the sync channel can even be used as an additional detector input.

### Independent channels, 1 ps resolution

The input channels of the HydraHarp 400 feature a dead time of < 85 ns, which allows high count rates of up to 12.5 million counts/sec per channel at a highly stable, crystal calibrated time resolution of 1 ps. Along with the extremely low differential non-linearity of the instrument, data of excellent quality can be obtained. As a special feature, an external time base from, e.g., an atomic clock can be used to synchronize the internal clock in relation to other timing devices. The instrument's timing resolution is well matched even to the fastest detectors currently available. All input channels are equipped with Constant Fraction Discriminators (CFD) triggering on the falling edge.

### Adjustable delay in each input channel

Each input channel has an internally adjustable delay with a  $\pm 100$  ns range permitting to adjust the relative timing between the channels with 1 ps resolution. This unique feature of PicoQuant timing electronics eliminates the need for specially adapted cable lengths or cable delays for different experimental set-ups.

### Histogramming range up to 2 s

The HydraHarp 400 offers 65536 histogram bins per input channel and allows to collect more than 4 billion counts (32 bits) per bin. Histograms can cover an extremely large time span between 65 ns and 2.19 s, depending on the chosen resolution per time bin, which can be varied between 1 ps and 33.5  $\mu$ s.

### Time tagging at 40 million events/sec

The HydraHarp 400 permits to capture time-tagged data in T2 and T3 mode with a sustained throughput of typically 40 million events/sec. External signals can be used to synchronize the device with other hardware such as scanners for, e.g., Fluorescence Lifetime Imaging (FLIM).

### Easy-to-use software or custom programming

The HydraHarp 400 software for Windows provides all functions necessary to acquire data in histogramming as well as in time tagging mode. An integrated online correlator for TTR data permits to monitor Fluorescence Correlation Spectroscopy (FCS) experiments at count rates of up to one million counts/sec. A programming library allows building custom applications using, e.g., LabView, Matlab, C++ or, Delphi.

### Application example

#### Optical mammography

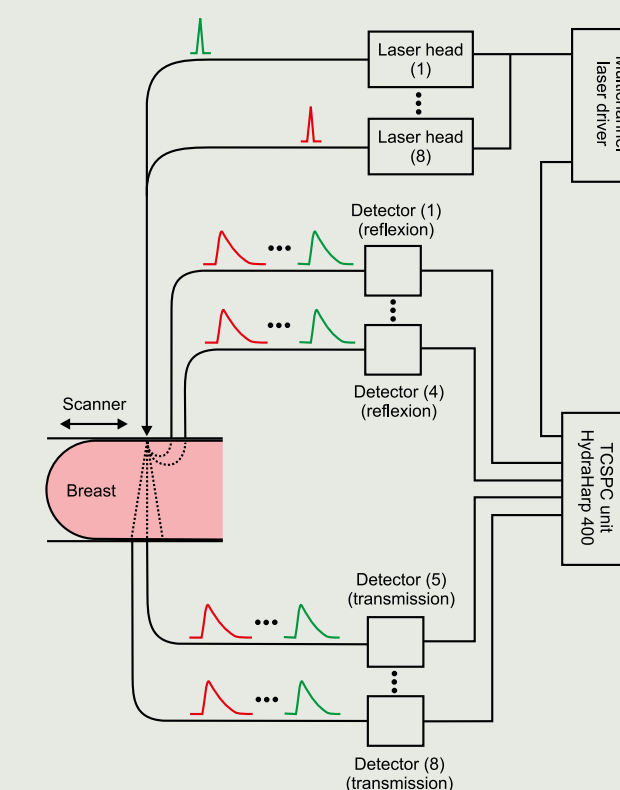

Sketch of a basic set-up for optical mammography. Optical mammography is a new method for breast cancer diagnostics. Instead of X-rays, this method uses laser light. The breast tissue is imaged in vivo by using pulsed laser radiation of several wavelengths simultaneously in combination with time-resolved transmission and reflection measurements to estimate optical properties of different types of breast tissue and tumors. Especially the possibility to acquire data with high temporal resolution on multiple parallel detection channels make the HydraHarp 400 an ideal choice for optical mammography.

# TimeHarp 260

## TCSPC and MCS board with PCIe interface

The TimeHarp 260 is a compact, easy-to-use, Time-Correlated Single Photon Counting (TCSPC) and Multi-Channel Scaler (MCS) board with PCIe interface. It is based on a custom TDC design that offers an ultrashort dead time even at high temporal resolutions. The board is available in two versions with either 25 ps (PICO module) or 250 ps (NANO module) base resolution.



### KEY FEATURES

- one or two independent input channels and common sync channel
- two models with either 25 ps (PICO) or 250 ps (NANO) base resolution
- ultrashort dead time (< 25 ns for PICO, < 1 ns for NANO)
- time tagging with sustained count rates of up to 40 Mcps



### Application example

#### Measurement of singlet oxygen decay

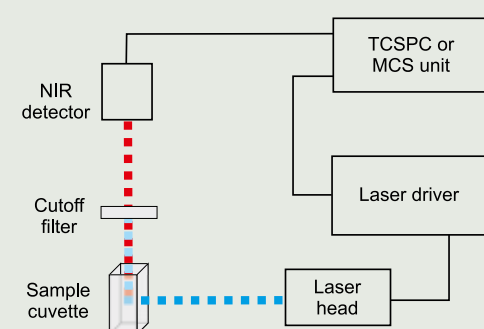

Sketch of a basic set-up to study singlet oxygen. The reactive properties of singlet oxygen are, for example, used to destroy cancer cells in photodynamic therapy. The sample is excited by a pulsed laser and the emitted fluorescence is detected using a NIR sensitive detector. For lifetime measurements, either Time-Correlated Single Photon Counting (TCSPC) or Multi-Channel Scaler (MCS) is used for data acquisition.

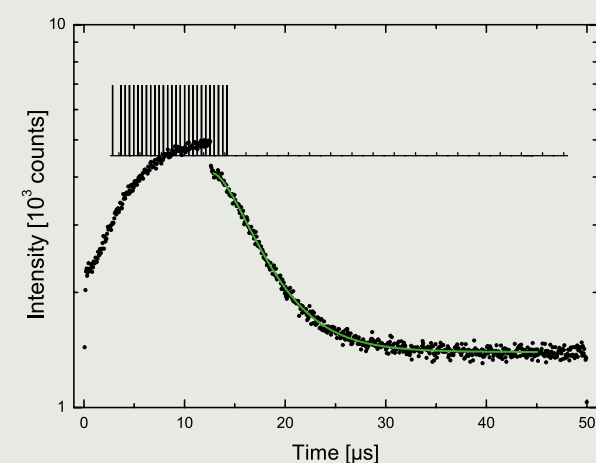

The example shows the time-resolved singlet oxygen emission produced by H<sub>2</sub>TTPS in acetone using burst mode excitation, i.e., first multiple laser pulses are used to deposit energy into the sample and then the excitation is stopped long enough to capture the comparably slow decay of the sample. A tail fit yields a lifetime of 3.4 ± 0.3 μs, which is in excellent agreement with the published literature value.

### Multiple input channels for highly flexible use

Each version of the TimeHarp 260 is available in different configurations with either one or two independent detection channels. They can be used as detector inputs for coincidence correlation experiments or as independent stop inputs for TCSPC. A dedicated common sync input is provided for TCSPC with fast excitation sources with stable repetition rates of up to 100 MHz. In T2 time tagging mode, the sync channel can even be used as an additional detector input.

### Adjustable delay in each input channel

Each input channel has an internally adjustable delay with a ±100 ns range at either 25 ps (PICO) or 250 ps resolution (NANO). This unique feature eliminates the need for specially adapted cable lengths or cable delays for different experimental set-ups.

### PICO module for high resolution TCSPC

The TimeHarp 260 PICO features a digital time resolution of 25 ps and is well matched to the timing resolution of the majority of photon detectors. All input channels are equipped with Constant Fraction Discriminators (CFD) triggering on the falling edge. The board features an ultrashort dead time of < 25 ns per channel allowing very high measurement rates of up to 30 million counts/sec in histogramming mode. An optional "long range mode" extends the histogram range up to 171 s, which permits to study dynamics from picosecond up to second time scales with just a single board.

### NANO module for MCS

The TimeHarp 260 NANO is designed for ultimately short dead time at a moderate time resolution of 250 ps. Because

of the short dead time of < 1 ns and the long histogram range of up to 68 s, it is particularly suited for traditional Multi-Channel Scaler (MCS) applications. Software-adjustable discriminators and polarity switches allow the board to be interfaced to a wide range of signal sources. Its multi-stop capability allows efficient recording of long-lived fluorescence and luminescence decays with correspondingly slow excitation rates, yet at very high detector count rates.

### Time tagging at 40 million events/sec

The TimeHarp 260 permits to capture time-tagged data in T2 and T3 mode with a sustained throughput of typically 40 million events per second. External signals can be used to synchronize the device with other hardware such as scanners for, e.g., Fluorescence Lifetime Imaging (FLIM).

### Programmable trigger output

A special feature of the TimeHarp 260 is its trigger output, which can generate pulse repetition frequencies between 1 Hz and 10 MHz. This special feature can, e.g., be used to control external lasers.

### Easy-to-use software or custom programming

The TimeHarp 260 software for Windows provides all functions necessary to acquire data in histogramming as well as time tagging mode. An integrated online correlator for TTTR data permits to monitor Fluorescence Correlation Spectroscopy (FCS) experiments at count rates of up to one million counts/sec. A programming library allows building custom applications using, e.g., LabView, Matlab, C++, or Delphi.

### Application example

#### Fluorescence Correlation Spectroscopy (FCS)

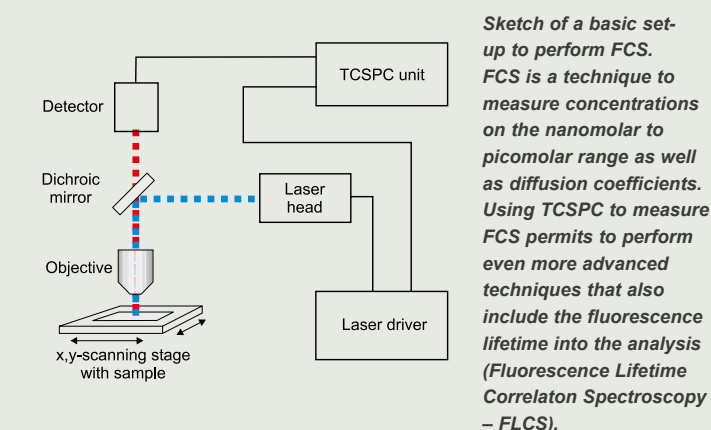

Sketch of a basic set-up to perform FCS. FCS is a technique to measure concentrations on the nanomolar to picomolar range as well as diffusion coefficients. Using TCSPC to measure FCS permits to perform even more advanced techniques that also include the fluorescence lifetime into the analysis (Fluorescence Lifetime Correlation Spectroscopy - FLCS).

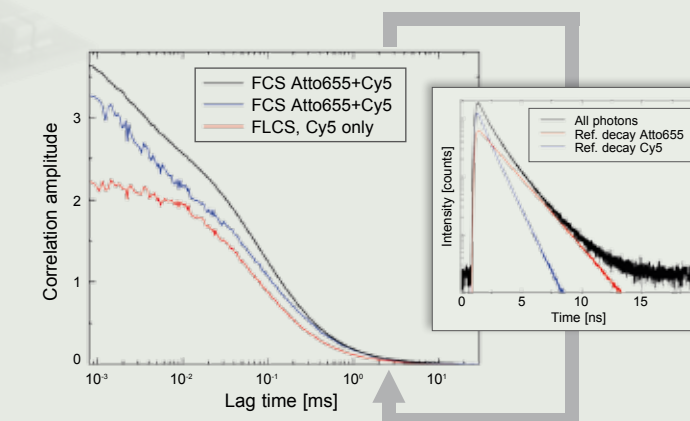

FLCS allows to separate the diffusion characteristics of two dyes measured from a mixture based on their different fluorescence lifetimes. The example shows the measured FCS curve of a solution containing Atto655 and Cy5 molecules in aqueous buffer. By a statistical evaluation which takes the different decay characteristics of the dyes into account, the individual auto-correlation curves of Atto655 and Cy5 can be reconstructed.



# PMA Series

## Photomultiplier detector assembly

The PMA detector is a single photon sensitive, fully integrated photon sensor with fast time response and low noise. The PMA incorporates a fast photomultiplier tube, a high voltage power supply, and a pre-amplifier. Thermoelectric cooling and automatic overload protection are optionally available.

The PMA Series is built around a photomultiplier tube (PMT) that already incorporates the necessary high voltage power supply. The PMT's are selected for best timing performance but with no compromise regarding detection efficiency.

### Spectral ranges between 185 nm and 920 nm

Three different photocathodes can be incorporated into the PMA Series to meet different needs. They differ in the spectral range, detection efficiency, and dark count rate. The covered spectral range extends from 185 nm to 920 nm with a quantum efficiency that can be as high as 40 % at 400 nm with dark count rates below 50 counts/sec for the blue sensitive version. A thermoelectrically cooled housing is additionally available to reduce the dark count rate.

### Timing resolution down to 140 ps

The PMA Series detectors feature a timing resolution which can be as fast as 140 ps with an active area of 8 mm in



diameter, making the detector suitable for virtually all optical set-ups used in photon counting experiments. Detectors of the PMA Series are typically used in set-ups where the light is collected from a larger volume, such as mm sized cuvettes in fluorescence spectrometers or tissue surfaces in diffuse optical imaging. They are also perfectly suited for confocal scanning microscopes in a non-descanned detection scheme.

### Integrated shutter, overload protection

The housing is available in two different versions. Standard PMA detectors feature a safety shutter, which can be interlocked with, e.g., a sample chamber lid. Cooled versions additionally incorporate an automatic overload protection function that closes the shutter in case of over-illumination.

### Housing with RF and magnetic shielding

The PMA Series detectors are built in a gold plated iron housing to achieve high level of RF and magnetic shielding and protection against the interference from other devices. The built in pre-amplifier is specially aimed at timing sensitive applications such as Time-Correlated Single Photon Counting (TCSPC). The detector is powered by a standard desktop power supply.

### Application example

Quantum efficiency curves of the PMA Series

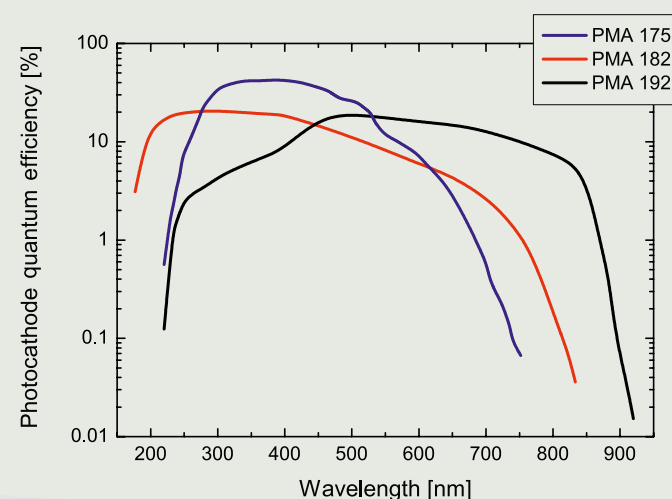

# PMA Hybrid Series

## Hybrid photomultiplier detector assembly

The PMA Hybrid is a compact single photon sensitive detector based on a fast hybrid photomultiplier tube with peltier cooler to reduce the dark count rate. The detector includes a high voltage power supply and pre-amplifier with overload protection and emergency shut down procedure if the detector count rate reaches a critical limit.

The PMA Hybrid is built around a photomultiplier tube that incorporates a photocathode and a silicon avalanche photodiode in an evacuated electron tube. It therefore combines the large active area of photomultiplier tubes with the very good timing resolution of avalanche diodes.

### Spectral ranges between 220 nm and 900 nm

Three different photocathodes can be incorporated into the PMA Hybrid to meet different needs. They differ in spectral range, detection efficiency, timing resolution, size of the active area, and dark count rate. The covered spectral range extends from 220 nm to 900 nm with a detection efficiency that can be as high as 45 % at 500 nm with dark count rates below 100 counts/sec for the blue sensitive version. All detectors include a peltier cooler to stabilize operation temperature and thus detector performance.

### Timing down to 50 ps, no afterpulsing

All PMA Hybrid detectors have a very good timing resolution that can even reach values down to 50 ps (FWHM) for the blue sensitive version. In contrast to other detector types, afterpulsing is not measurable. The active area of a PMA Hybrid is several millimeters in diameter, which makes it suitable for almost all optical set-ups used in photon counting experiments. Due to their fast timing response, good detection efficiency, and especially the absence of afterpulsing, these detectors are now becoming the standard detector for many photon counting and timing experiments, ranging from classical spectroscopy of bulk materials to imaging and correlation spectroscopy in microscopy applications.

### Housing with dedicated RF shielding

The PMA Hybrid is built in a nickel coated aluminum housing to achieve high level of RF shielding and protection against interference from other devices. The built-in pre-amplifier is specially aimed at timing sensitive applications such as Time-Correlated Single Photon Counting (TCSPC). The detector is powered by a standard desktop power supply.



### Application example

Detection efficiency curves of the PMA Hybrid Series

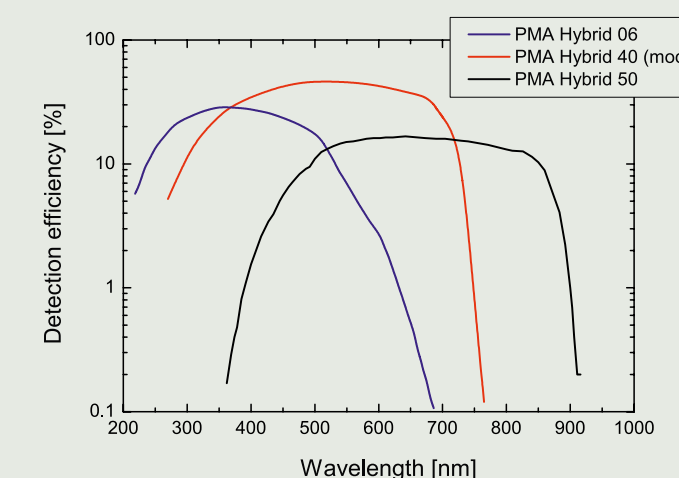

# FluoFit

## Fluorescence decay analysis software

The FluoFit software package is a powerful global analysis software for fluorescence decay and anisotropy measurements. Tail fitting as well as a numerical reconvolution algorithm to account for the finite Instrument Response Function (IRF) can be applied. An advanced error treatment using different established procedures permits to judge the quality of the fit.

### Iterative reconvolution or tail fitting

FluoFit implements an iterative reconvolution of the instrument response function using nonlinear least-squares error minimization based on the Levenberg-Marquardt or maximum likelihood estimation algorithm. Tail fitting is also supported for data that does not require reconvolution of the instrument response function. Initial estimates for the fit parameter are provided by a fast, automatic Monte Carlo search. Robust algorithms and solid implementation lead to quick and reliable convergence after only a few iterations. A flexible data weighting scheme allows fitting not only photon counting data, but also decay curves obtained by analogue hardware.

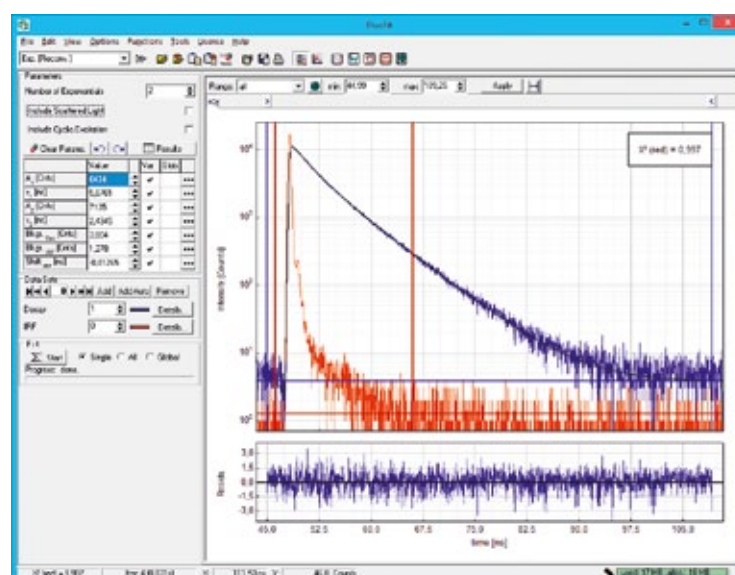

### Exponential decay models up to 4th order

Standard exponential models (up to four-exponential terms) can be fitted to the recorded data. IRF and decay backgrounds, time shift, as well as other optional parameters can be included as fit parameters. Any model parameter can also be adjusted manually and kept fixed during fitting. Start parameters for the fitting algorithm can be determined automatically or entered manually. The fitting limits are easily adjusted individually with graphical sliders for the IRF as well as the decay data.

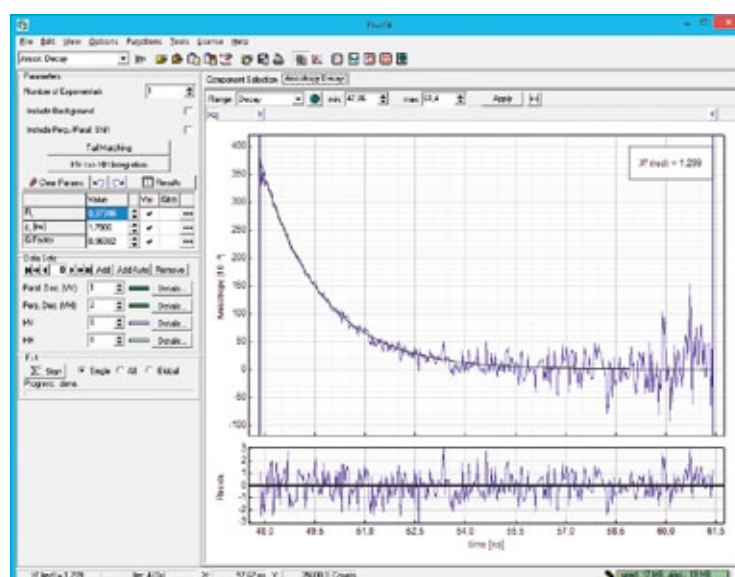

### Different lifetime distribution models

Besides exponential decay models, FluoFit also permits to fit different lifetime distribution models (Gaussian, Lorentzian, and stretched exponential) to the experimental data. Again, the software allows to freely vary the number of fit parameters, including IRF and signal background as well as time shift.

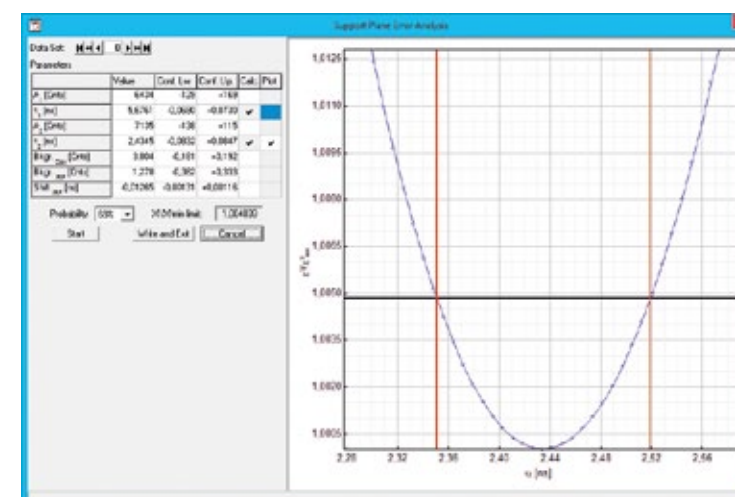

### Advanced anisotropy decay analysis

FluoFit also supports advanced analysis of fluorescence anisotropy via multi-exponential anisotropy reconvolution fits of the parallel and perpendicular polarized decay curves. The necessary G-factor can be fitted, entered manually or even calculated directly from the experimental data.

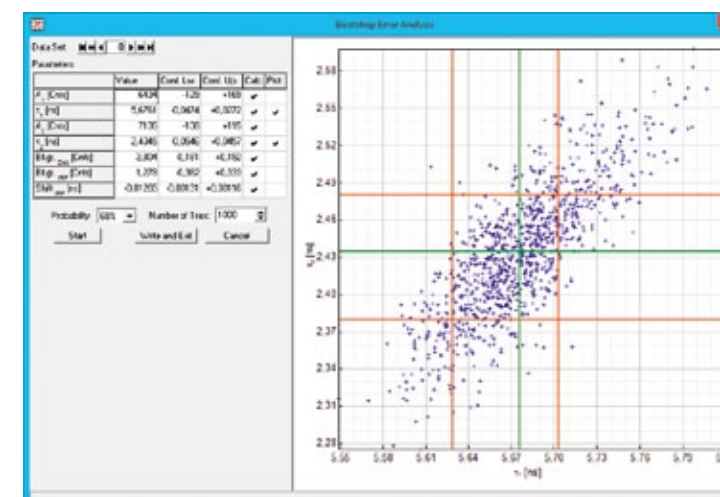

using different methods such as asymptotic standard errors (ASE), support plane analysis and bootstrap.

### Easy-to-use graphical user interface

FluoFit supports data files from all PicoQuant TCSPC systems as well as ASCII data files. Instrument response and fluorescence decay may be imported from different sources or copied directly via the Windows clipboard. A comprehensive help file is provided for ease of use. User preferences are widely adjustable and can be automatically stored and retrieved. The software is available for Windows and features a modern and easy-to-use graphical user interface. Results can be printed, saved, and exported for later reference.

### Global and batch fitting for all models

Global and batch fitting for all included models are also possible with the FluoFit software. In batch fitting, several datasets are automatically fitted to the same model, whereas in global fit, several datasets are linked by one or more parameters which are globally valid for all datasets. As such global parameters have to have the same value for all datasets, the number of parameters is effectively reduced in comparison to fitting all datasets separately.

### Advanced error treatment

FluoFit includes several established methods for error assessment of the fitting results. This includes the calculation of a reduced chi-square value as well as weighted residual for each fitting parameter. An auto-correlation trace can be calculated for assessment of the goodness of fit. An even more advanced error analysis is possible by rigorous analysis

*“The HydraHarp 400 is an ideal device for multichannel correlation studies in astronomy.”*

*Elliott Horch,  
Southern Connecticut State University, USA*

# SymPhoTime 64

## Fluorescence lifetime imaging and correlation software

The SymPhoTime 64 software package is an integrated solution for data acquisition and analysis. Its clearly structured layout and powerful analysis routines allow the user to focus on the results rather than on the data processing. The software is available in four different packages in order to meet the different needs of individual users.

The SymPhoTime 64 software is designed for a 64 bit operating system and features a graphical user interface (GUI), which guides the user through all necessary steps for an individual analysis or measurement process. Data dependencies are directly visible in the underlying workspace concept. An integrated scripting language (“STUPSLANG”) even enables the user to add new analysis procedures or customize existing ones.

### Easy data acquisition

SymPhoTime 64 is the dedicated data acquisition software for PicoQuant’s time-resolved confocal microscope MicroTime 200 and LSM upgrade kits. It can of course be used with custom set-ups based on PicoQuant TCSPC electronics. All data acquisition and analysis features of SymPhoTime 64 are based on the unique time tagging modes of the TimeHarp 260, PicoHarp 300, or HydraHarp 400, thus allowing a large range of data interpretation ranging from simple TCSPC histograms to complex imaging and correlation analysis.

### Adapted interfaces for image analysis

With SymPhoTime 64, analysis of (time-resolved) imaging measurements will be easier than ever before. The software provides specially adapted interfaces for many standard analysis procedures ranging from Fluorescence Lifetime Imaging (FLIM) to Förster Resonance Energy Transfer (FRET) and Anisotropy. A special pattern matching algorithm even enables the decomposition of an image into the contributions from individual subcomponents based on overall decay shapes, generating individual dedicated images for the separate contributions of, e.g., auto-fluorescence, FRET, and non-FRET species. Each interface only makes those

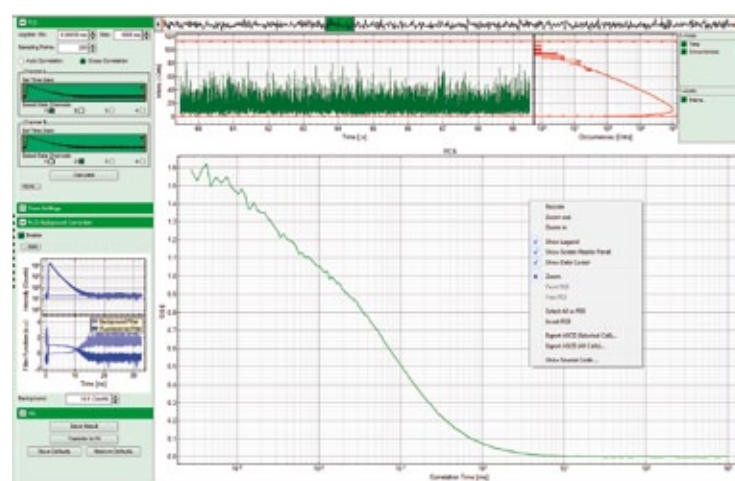
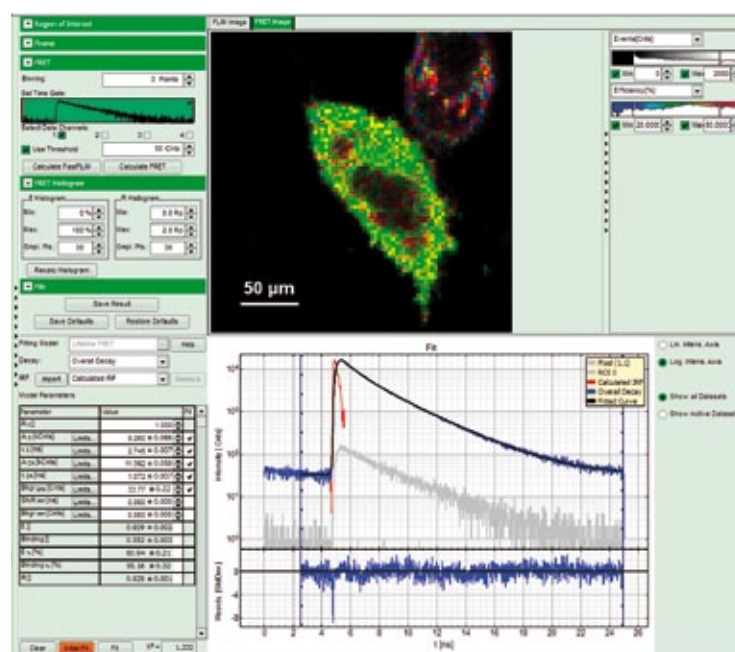

procedures available that are directly required for the individual analysis. This ensures to quickly learn the relevant methods and easily obtain correct analysis results.

*“The HydraHarp 400 is the ideal device for multiplexed TCSPC applications such as single-molecule and ensemble fluorescence spectroscopy and imaging with multiparameter detection (MFD).”*

*Claus A. M. Seidel, University of Düsseldorf, Germany*

### Ultrafast software correlator

SymPhoTime 64 also sets a new standard for analysis of fluorescence correlation spectroscopy measurements. The software provides a wide range of specially adapted correlation analysis procedures, which range from classical auto-correlation (FCS) and cross-correlation (FCCS) to lifetime based correlation analysis (FLCS) and total correlation. Several standard fitting models are already included in SymPhoTime 64 to determine meaningful physical parameters such as diffusion coefficients or molecular concentration of one or more species included in the sample. Even coincidence correlation analysis is possible based on the unique time tagging modes of the PicoQuant TCSPC modules. By exploiting the full power of multi-core computer systems, SymPhoTime 64 is one of the fastest software correlators on the market.

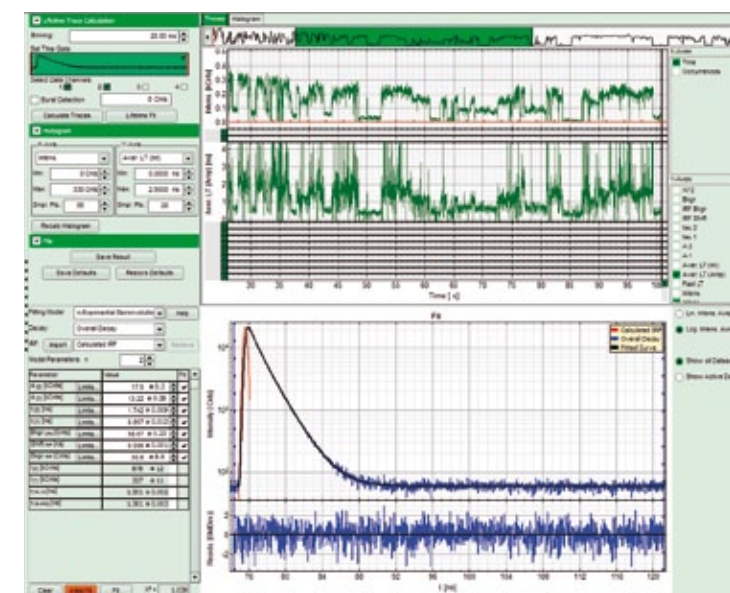
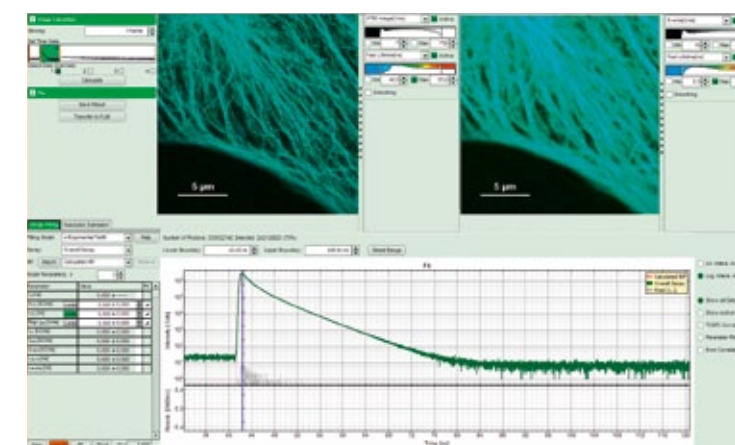

### Intensity time trace analysis

The analysis of fluorescence intensity time traces is another core feature of SymPhoTime 64. Fluorescence intensity time traces display the measured fluorescence dynamics and can be analyzed in a variety of ways. Prominent examples are FRET, Pulsed-Interleaved Excitation FRET (PIE-FRET) or, anisotropy as well as classical single molecule methods such as on/off histograms, burst size histograms, or fluorescence lifetime traces. The results from a fluorescence lifetime analysis of the time trace can even be visualized through correlograms displaying dependencies of the various parameters.

### STED super-resolution

SymPhoTime 64 also supports the analysis of super-resolution measurements obtained by Stimulated Emission Depletion (STED) microscopy. Different data acquisition modes including interleaved trains of excitation and STED laser pulses are integrated into the user interface. STED images as well as time-gating for gSTED are displayed online during data acquisition. Multiple image processing approaches such as gSTED and pattern matching are implemented for even further improvement of the resolution.

# Beyond Photon Counting and Timing

PicoQuant is not only known for manufacturing state-of-the-art photon counting and timing electronics, but is also leading in the field of picosecond pulsed diode lasers as well as fluorescence lifetime systems. We offer a large choice of individual modules or complete systems, individually matched to the requirements of the user.

## Pulsed Laser Systems

Picosecond pulsed diode lasers are one key area of PicoQuant's leading technological competence. Notably, the PDL Series and LDH Series of picosecond pulsed diode lasers have become an acknowledged brand worldwide. These versatile laser systems provide picosecond pulses on demand with repetition rates of up to 80 MHz in a broad spectral range from 266 nm to 2000 nm with average output powers in the lower milliwatt range. The product range is completed by the Solea, a freely triggerable supercontinuum laser that emits in the visible range, amplified diode lasers with output powers of a few watts, modulated lasers, and lasers with programmable pulse shapes.

## Fluorescence lifetime systems

PicoQuant offers compact or automated modular time-resolved fluorescence spectrometers, lifetime upgrade kits for laser scanning microscopes, and complete time-resolved confocal microscopes with 3D scanning and super-resolution imaging capabilities using STimulated Emission Depletion (STED) for applications like Fluorescence Lifetime Imaging (FLIM), Fluorescence (Lifetime) Correlation Spectroscopy (F(L)CS), or Förster Resonance Energy



Transfer (FRET). All systems are available with variable configurations that meet the requirements of even the most demanding analytical applications such as single molecule spectroscopy. Individual set-ups allow to resolve fluorescence lifetimes down to 10 ps or up to several hundred milliseconds. Samples can be liquids in standard cuvettes, membranes, cells or, even semiconductor wafers for in-line quality control.

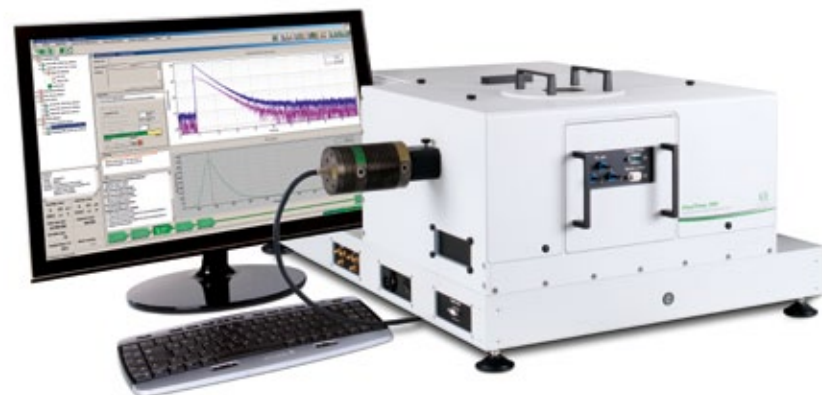

# PicoQuant

PicoQuant was founded in 1996 to develop robust, compact, and easy-to-use time-resolved instrumentation and systems. Since April 2008 sales and support in North America is handled by PicoQuant Photonics North America Inc.

Today, PicoQuant is known as a company leading in the field of pulsed diode lasers, time-resolved data acquisition, single photon counting, and fluorescence instrumentation. Our instruments are used all over the world. They are used in the laboratories of Nobel Laureates and help to prepare papers in high-ranking journals as well as carrying out routine quality control and production processes of global industrial players. Starting from traditional time-resolved fluorescence detection in bioanalytics, the range of applications is continuously increasing and includes semiconductor quality control, diffuse optical imaging and tomography, quantum information processing, optical detector testing, and telecommunications. Due to our easy-to-use products, researchers can now focus on their problems in biology, medicine, environmental science, quantum optics, or chemistry without needing a large background in physics, electronics, or optics.

## We offer state-of-the-art technology

Our intention is to offer state-of-the-art technology which has been co-developed and tested by renowned researchers, at a price affordable to scientific groups and price conscious industry. We have successfully teamed up with all major confocal microscopy companies to develop dedicated equipment that permits time-resolved fluorescence studies on



their laser scanning microscopes. Following this philosophy, we are always looking for new challenges. PicoQuant especially encourages OEM inquiries for its products, notably for applications where implementing time-resolved techniques were considered too expensive and cumbersome in the past.

## More than 20 years of R & D work

The combination of more than 20 years of R & D work, several thousand units sold, and cooperation with international experts for special applications provides a stable basis for new outstanding developments always driven by our customers' needs and inspirations. We invite you to visit our website or contact our product and application specialists directly to discuss your specific needs. And, of course, you are always welcome to visit our application labs during your travels to Germany.

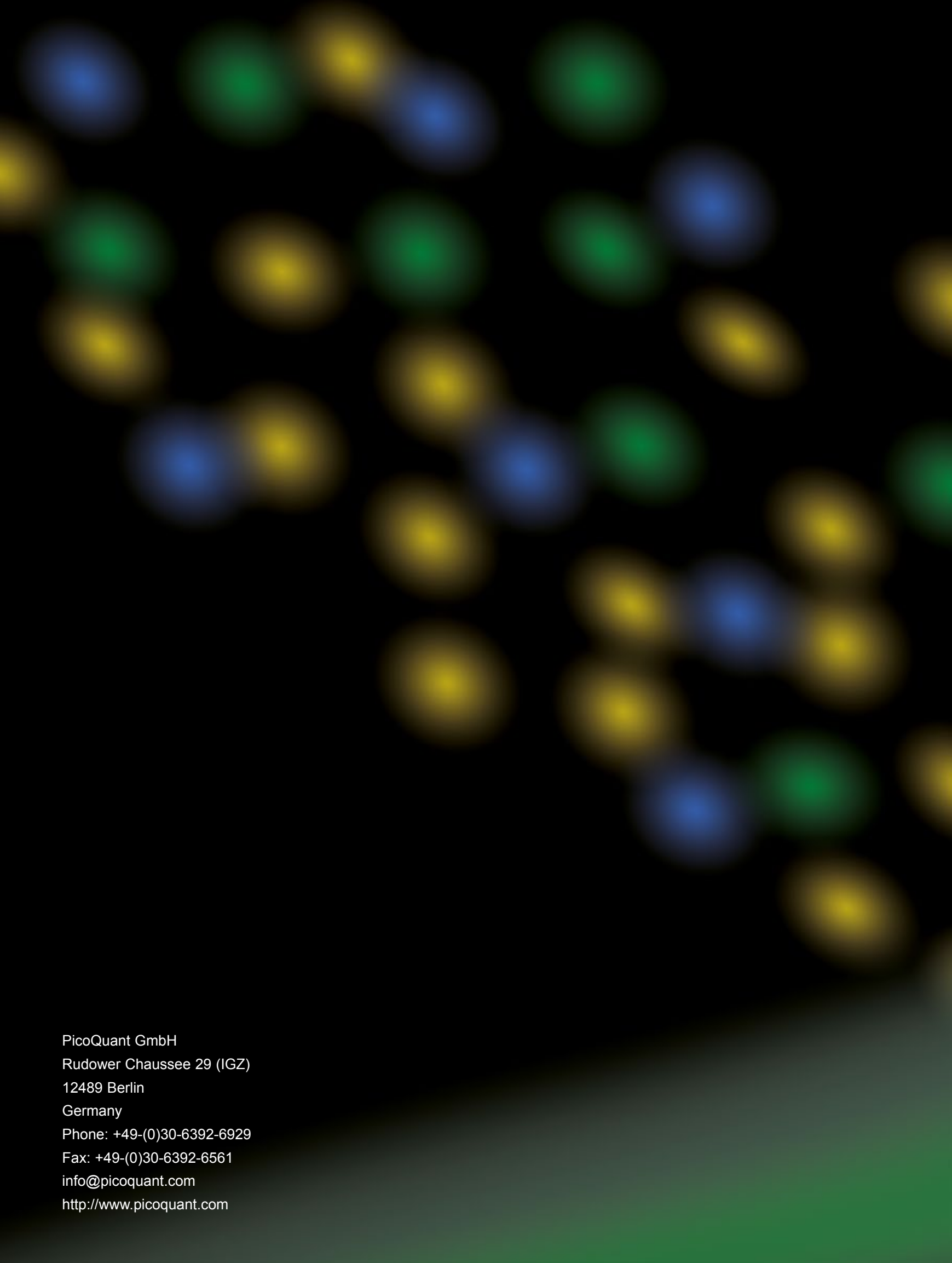

PicoQuant GmbH  
Rudower Chaussee 29 (IGZ)  
12489 Berlin  
Germany  
Phone: +49-(0)30-6392-6929  
Fax: +49-(0)30-6392-6561  
[info@picoquant.com](mailto:info@picoquant.com)  
<http://www.picoquant.com>